

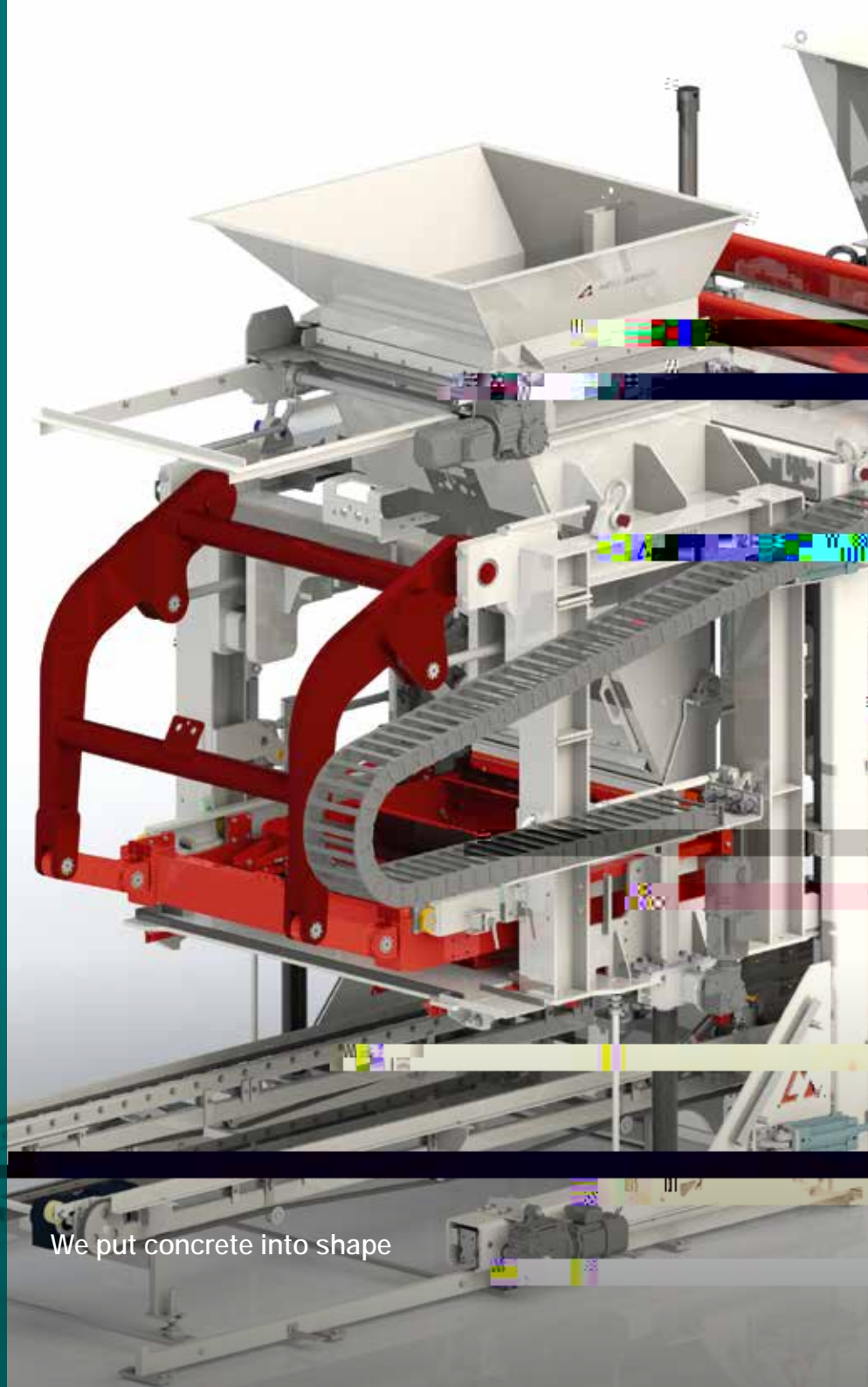

HESS GROUP

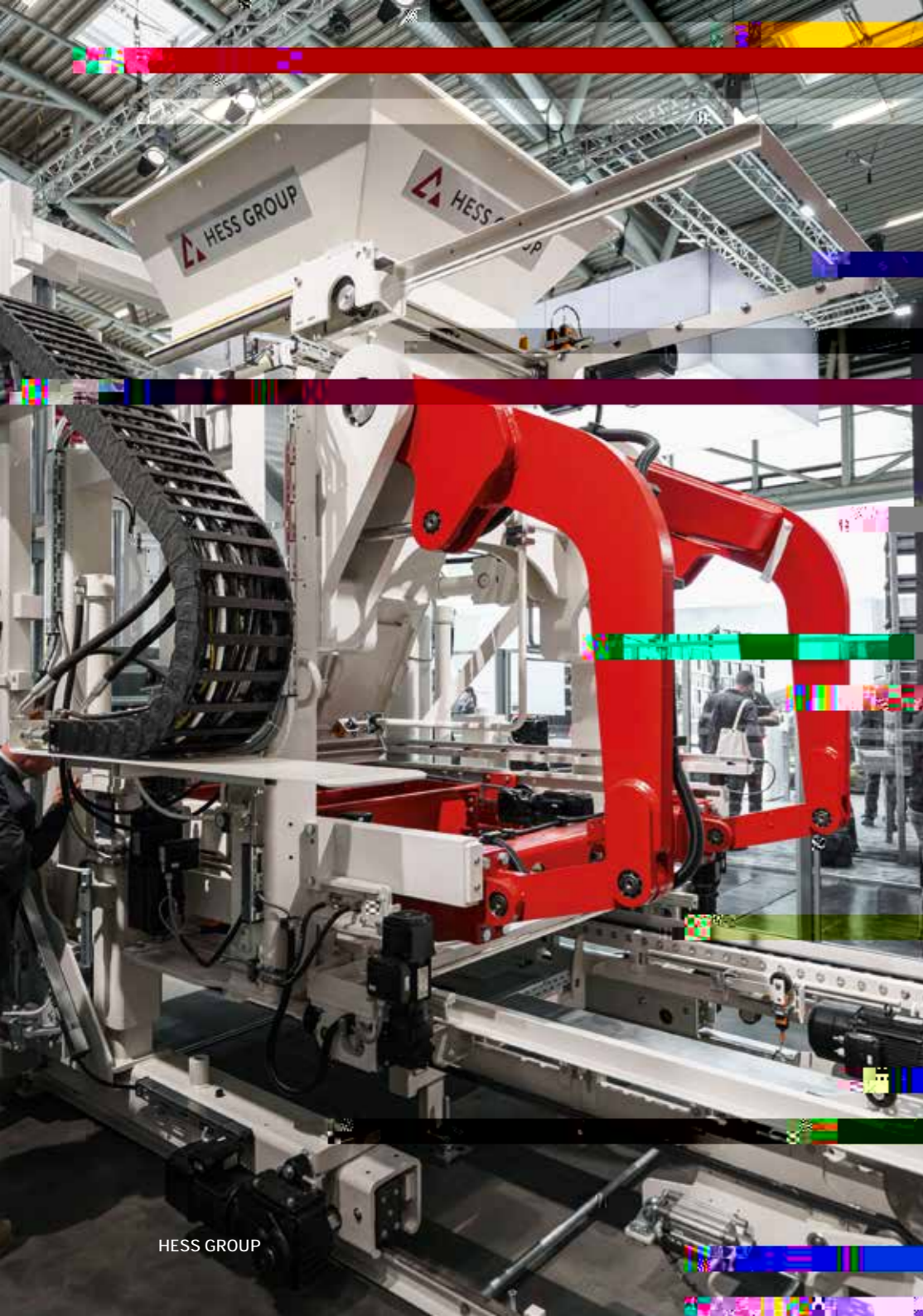

We put concrete into shape



HESS GROUP

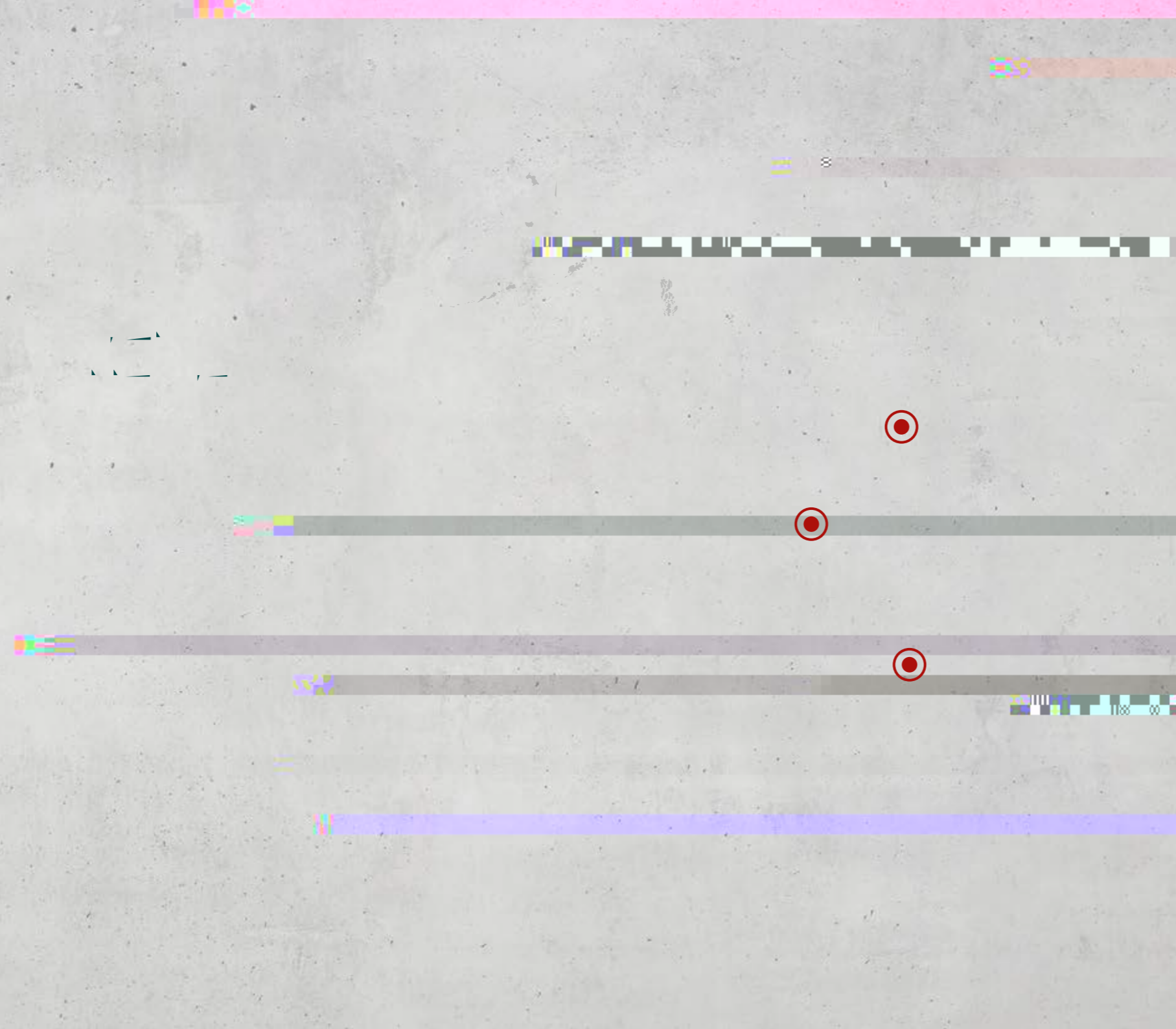

As an innovative manufacturer of high-quality concrete block and paver plants, we – together with our customers – ensure our mutual market leadership.

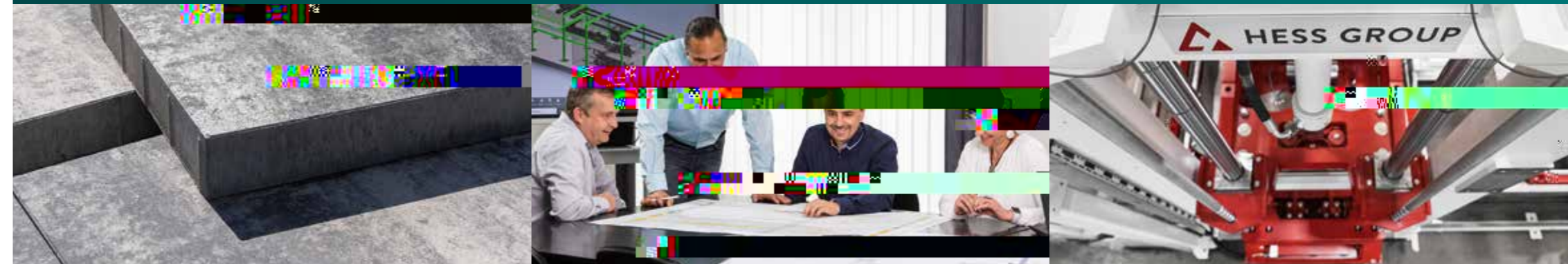

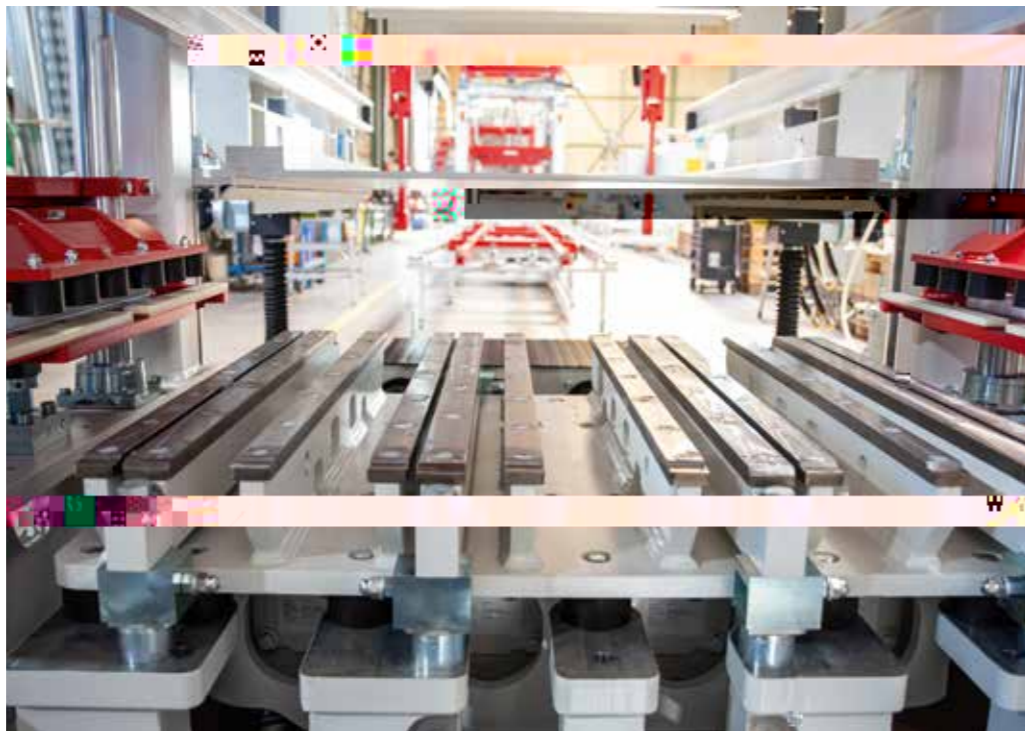
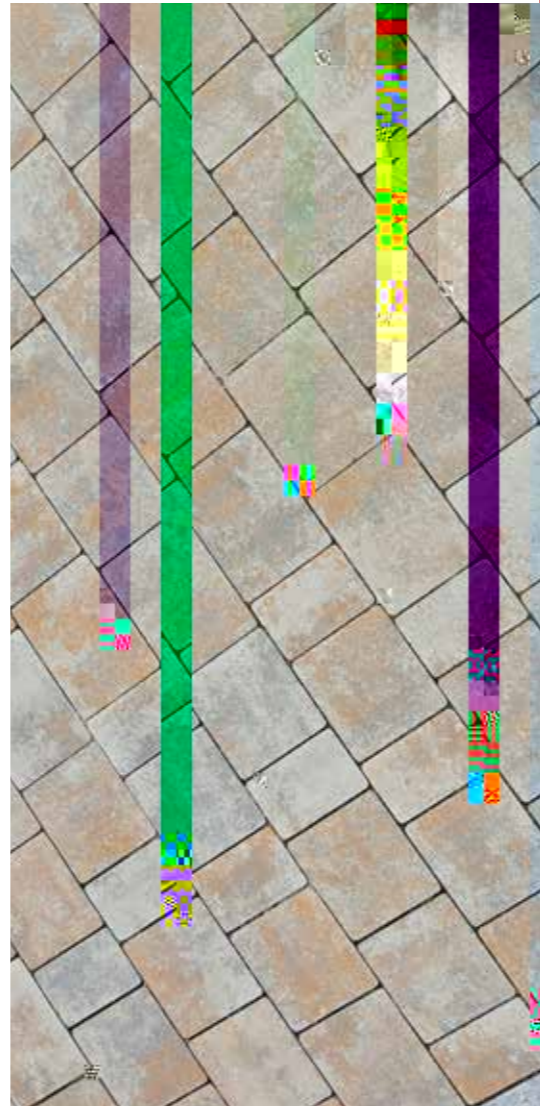
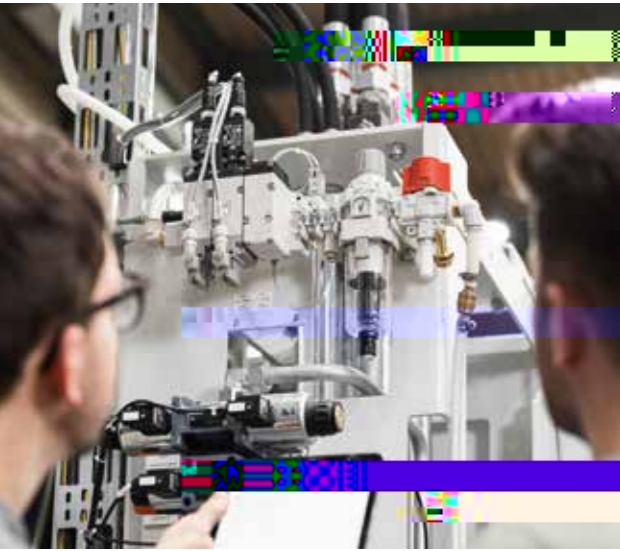

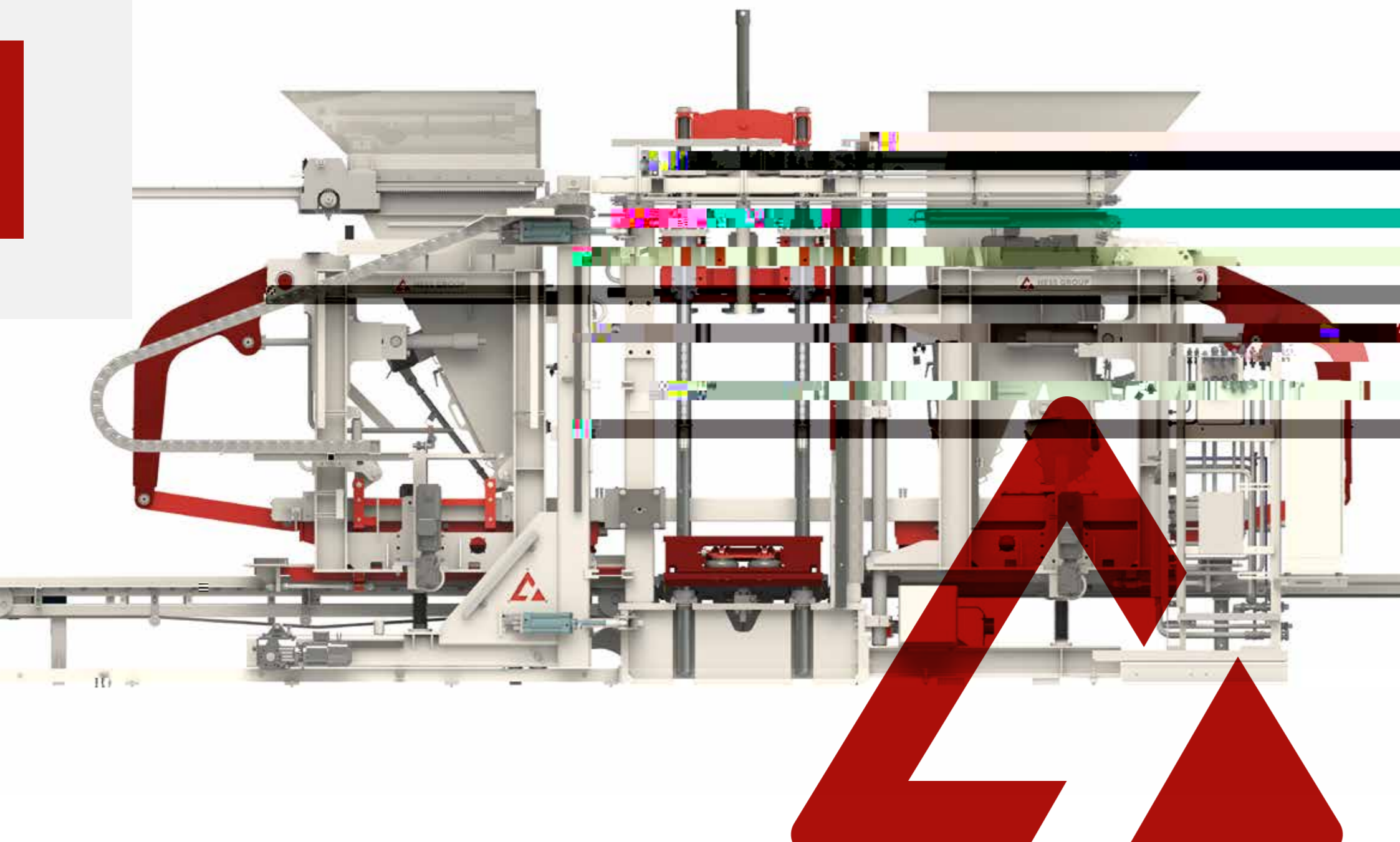

Oc MC, 0+noi njpo p q dñ jno a di trcdc
c i k nãrh i)Ocd a di t gñr nãjmm p

RH 1450



147.6050 CS B56.69 -12.472 rSCN6S2 gsq8577.812100448.4704 cm577.m2812.677.ISQ8577.8292.448.4704 cm577.m510.7677.ISQ8577.812100

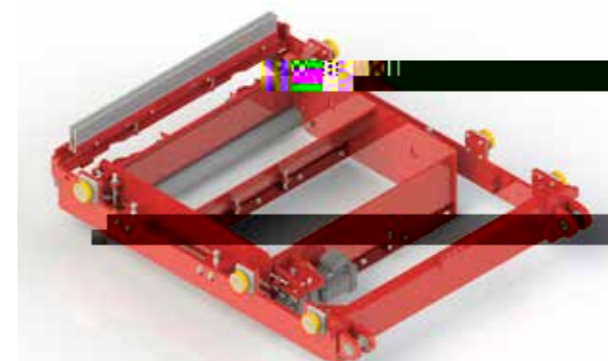
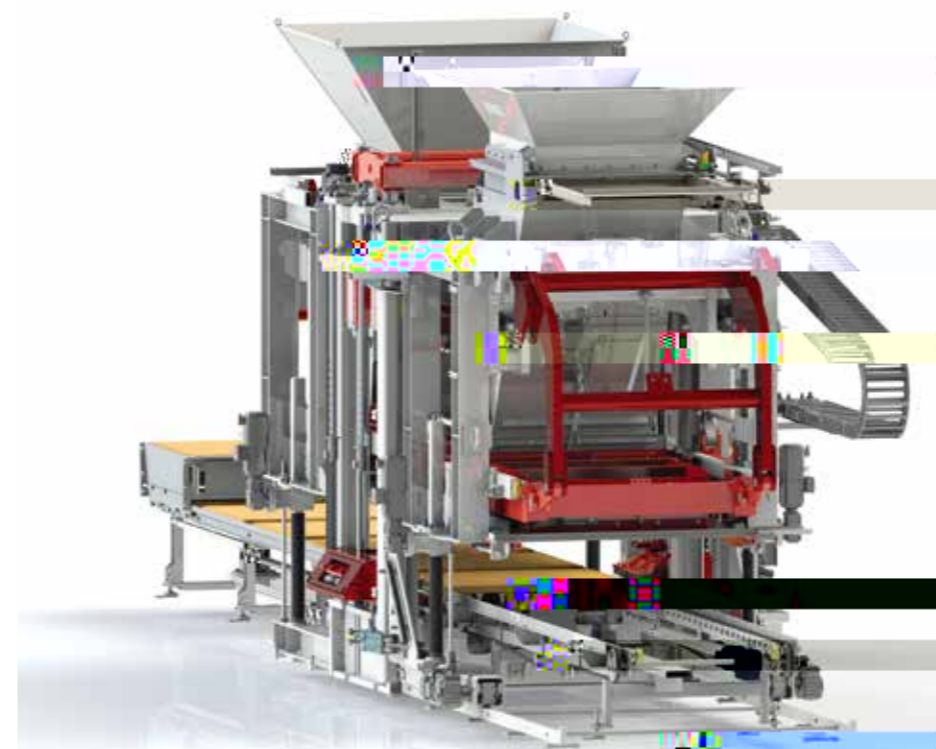

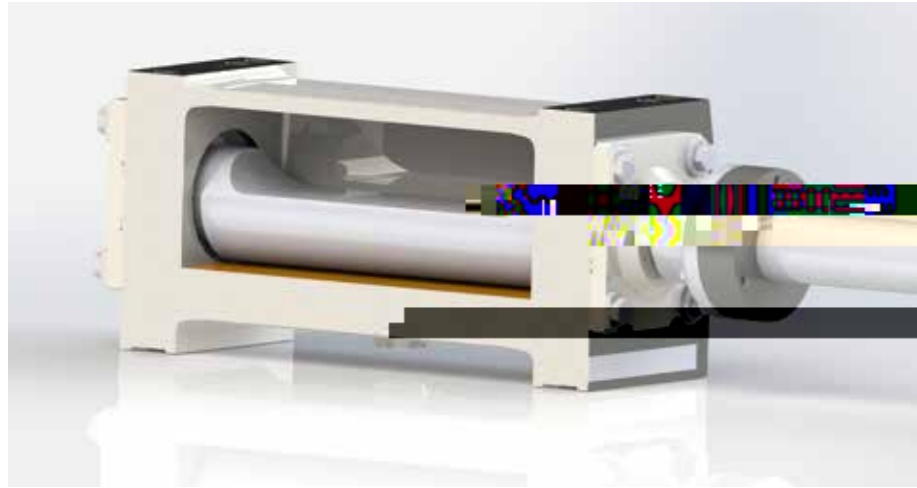

Model oil bath vibrator

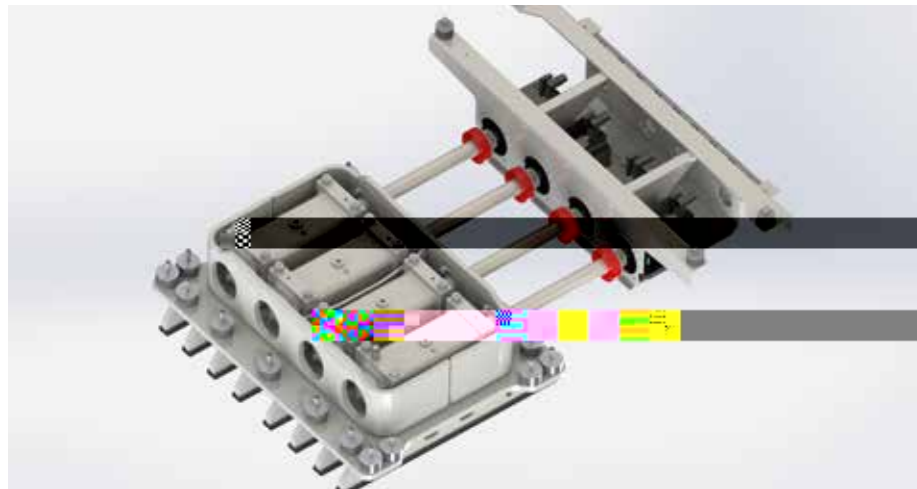

VarioTronic vibrating table, view from below

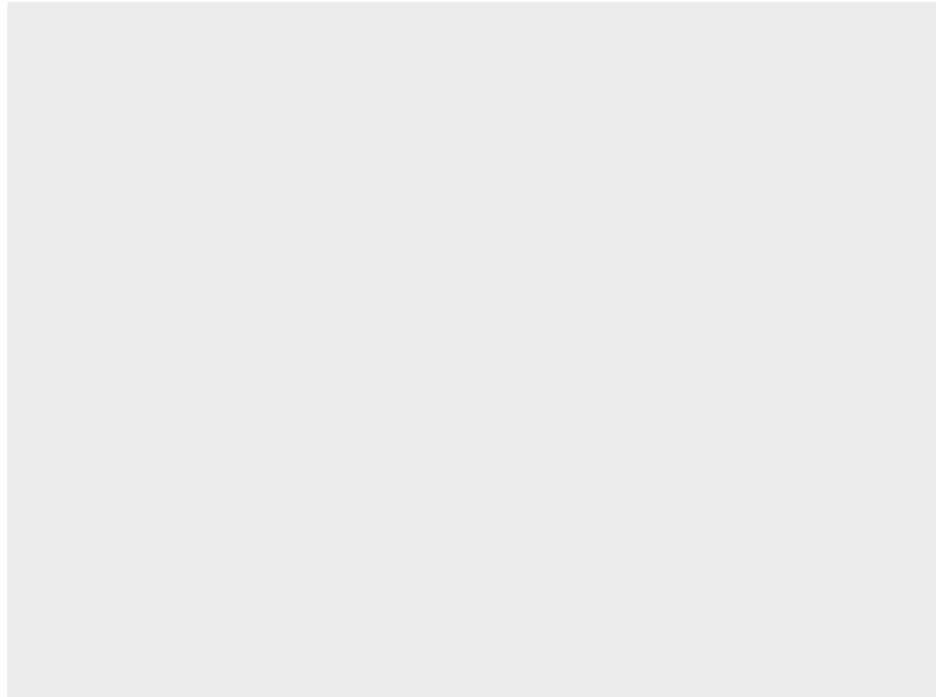

Colormix device with draw plate

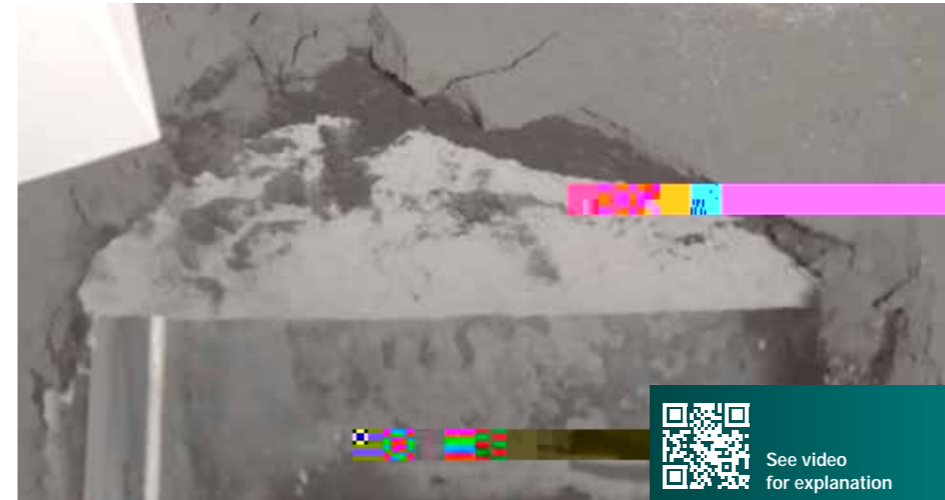

Colormix device with two layers of colored concrete



- jn(a dior t o j h ipa φm
-
-

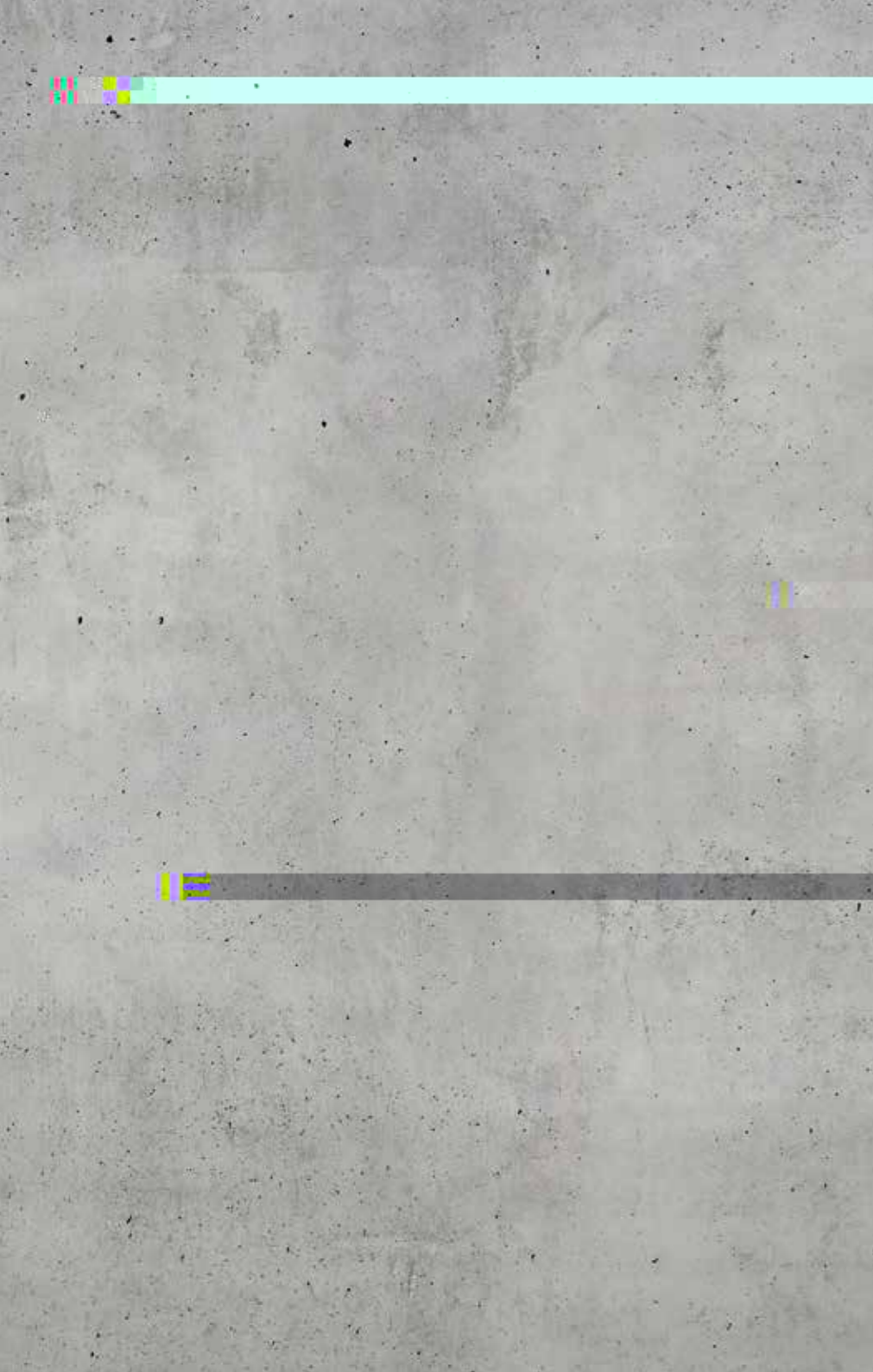

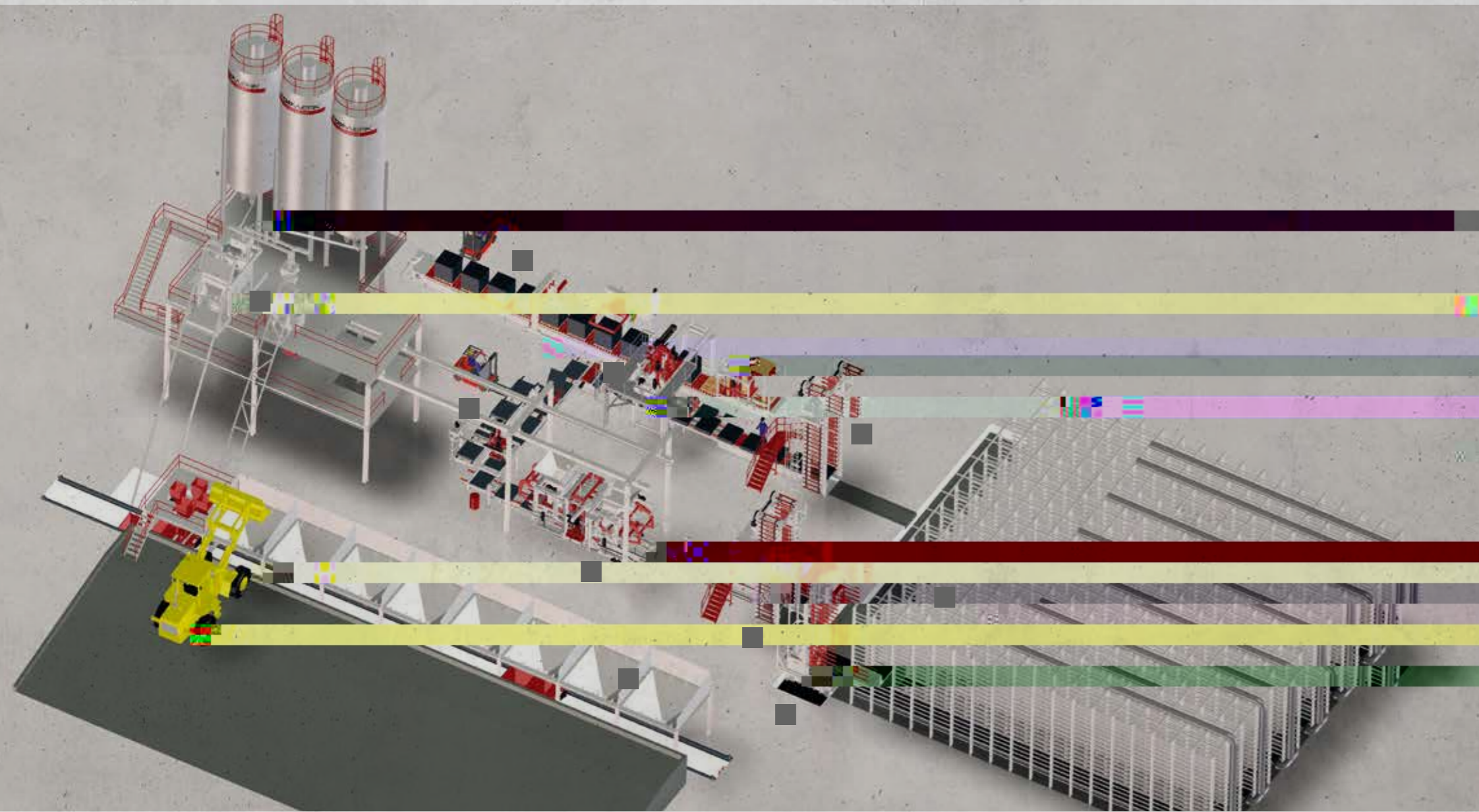

RH 1450 VA

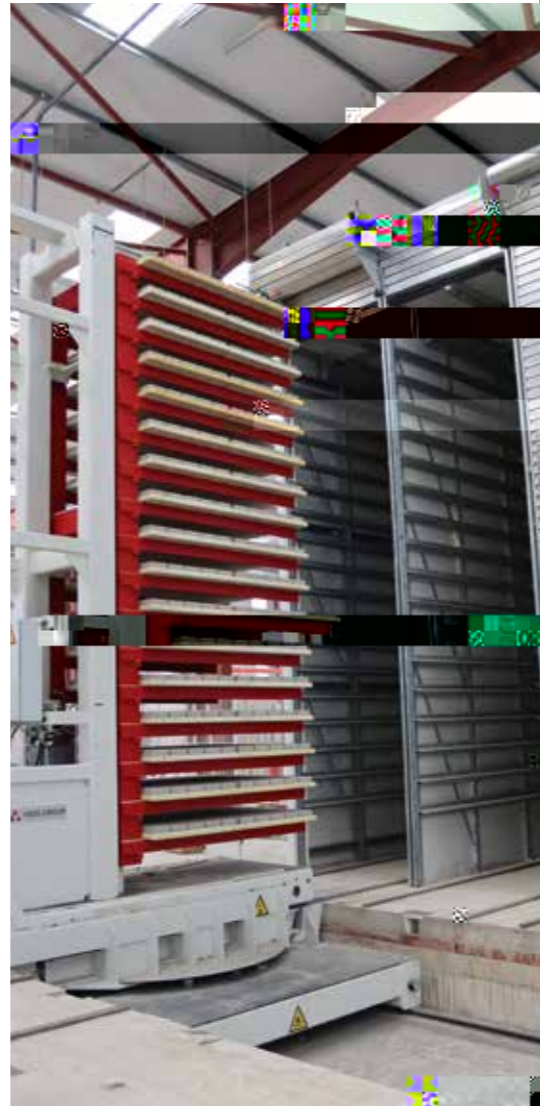
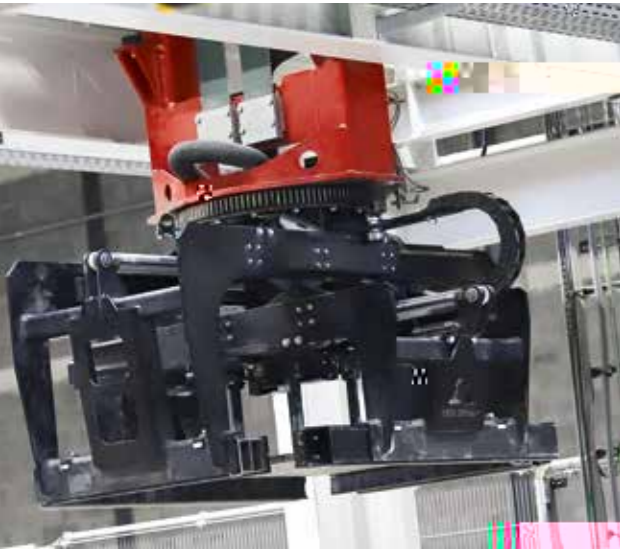



Interior view of mixer with raw materials

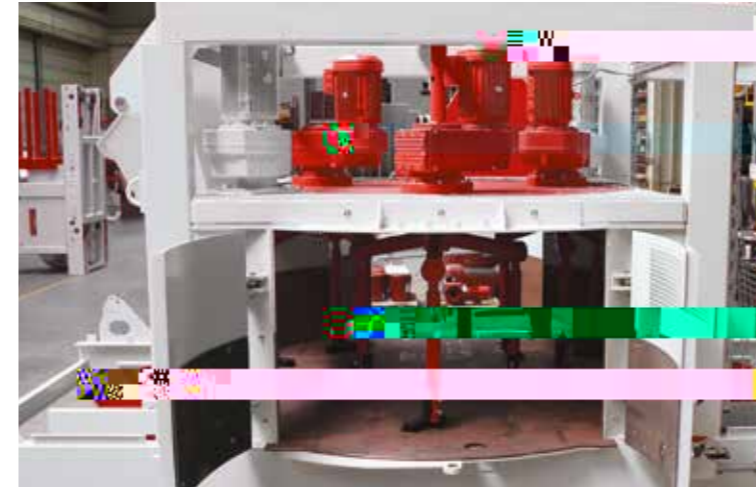

Interior view of base mix mixer



Color-Mix shuttle belt system

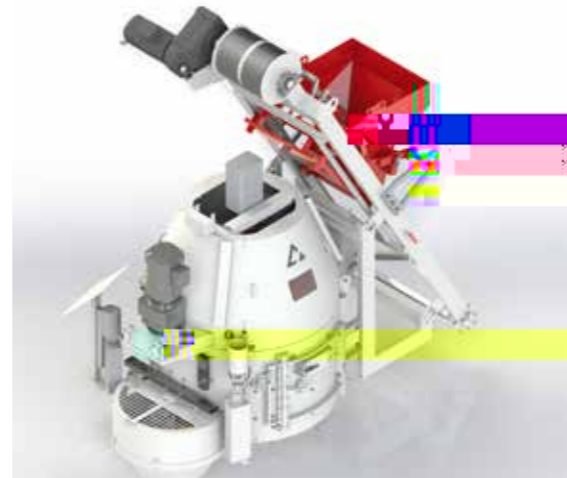

Face concrete mixer SM 500

TECHNICAL OVERVIEW OF BATCHING AND MIXING PLANTS

	SM 500	SM 1500	SM 2250	SM 3375	SM 4500
ൺ യൂ b g					
H s) യൂ b r ഫco fb					

-
-
-
-
-
- ഫി d i ഔ gnn ji mo mnd p i
-
-



Color-Mix Product

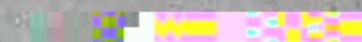
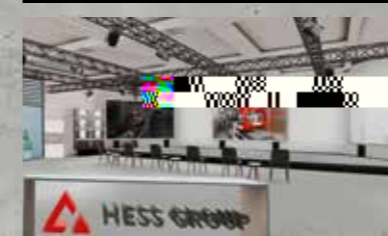
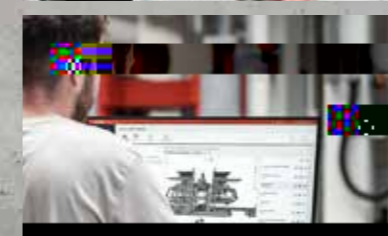



HESS Group GmbH

cji 5 4-2.1 421 +
@h d d aj c nnbrjpk) j h



We put concrete into shape